

| ITEM | PART NO. | MODEL NO. | QTY | DESCRIPTION |
|------|-------------------|--------------|-----|--|
| 1 | (SEE TABLE BELOW) | VBV-71XC-C | 1 | VBV-71XC-C CAMERA ONLY |
| 2 | (9859) | VBV-71XC-BKT | 1 | VBV-71XC-BKT CAMERA BRACKET |
| 3 | (3857) | VBV-71XC-SS | 1 | VBV-71XC-SS CAMERA SUNSHIELD |
| 4 | (3858) | VBV-71XC-FIX | 1 | VBV-71XC-FIXCAMERA FIXING KIT (NOT SHOWN) |
| 5 | (3860A) | VBV-71XC-IG | 1 | VBV-71XC-IG INSTALLATION GUIDE (NOT SHOWN) |

| PART NO. | MODEL NO. | CAMERA ONLY PART NO. | DESCRIPTION |
|----------|-----------|----------------------|-------------|
| (29088) | VBV-710C | 3659B | PAL |
| (28415) | VBV-711C | 3871B | NTSC |

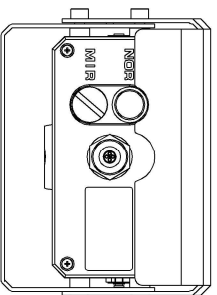

VIEW A

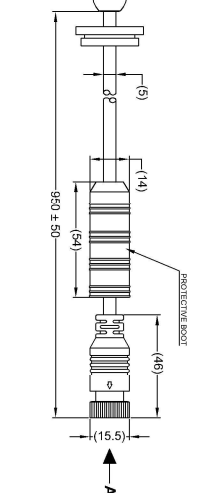
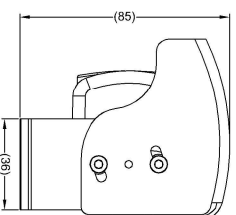
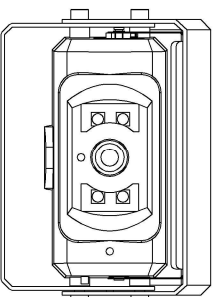
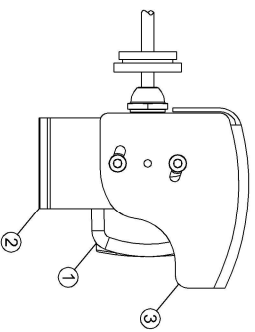
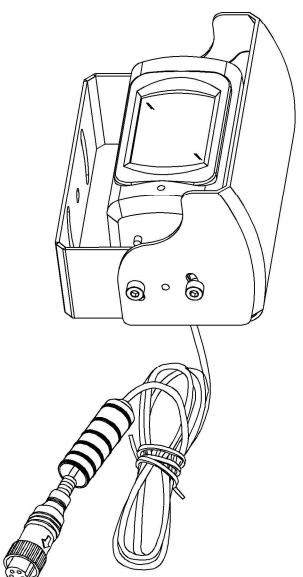
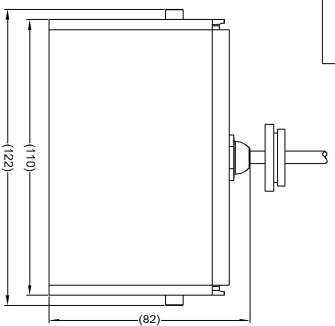
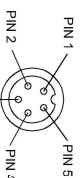

| PIN # | WIRE COLOUR | DESCRIPTION |
|-------|-------------|----------------|
| 1 | RED | +12VDC |
| 2 | WHITE | SHUTTER SIGNAL |
| 3 | BLACK | GROUND |
| 4 | YELLOW | VIDEO |
| 5 | BLACK | VIDEO |

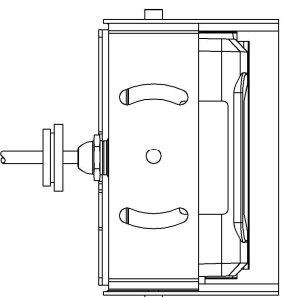

- NOTES:
- REFER TO PRODUCT SPECIFICATION FOR PRODUCT DETAILS.
 - REFER TO COMPONENT DRAWINGS FOR COMPONENT DETAILS.
 - CONNECTOR A IS BROWN.
 - FOR LABELING AND PACKAGING DETAIL REFER TO MASTER BOM

PROPRIETARY NOTICE

THIS DESIGN AND TECHNICAL INFORMATION APPEARING ON THIS DRAWING IS THE PROPERTY OF BRIGADE ELECTRONICS, AND IS DISCLOSED IN CONFIDENCE. IT IS NOT TO BE COPIED, REPRODUCED, REVEALED TO OR EXPLOITED BY OTHERS, EITHER IN WHOLE OR IN PART WITHOUT THE EXPRESS WRITTEN CONSENT OF BRIGADE ELECTRONICS.

Revision Notes:

| APR: | Drawn: | Checked: | Approved: | Date: |
|------|--------|----------|-----------|-------|
| | | | | |

BRIGADE
www.brigade-electronics.com

| | | | |
|--|-----------------------|----------------------------|--------------------------|
| Assembly Pl Approval Y.Zhang 13/12/16 | Approved by B.John | Checked by D.Richardson | Drawn by SLAVER |
| Angle of Projection Third Angle | Units mm | Scale N/A | Released 19/12/16 |
| Status Released | Part No SEE TABLE | Released 19/12/16 | Assembly Ref VBV-71XC |
| | | | BE-003518-00-16 |